

Art. Nr. 2839996
1/6



21.02.2024





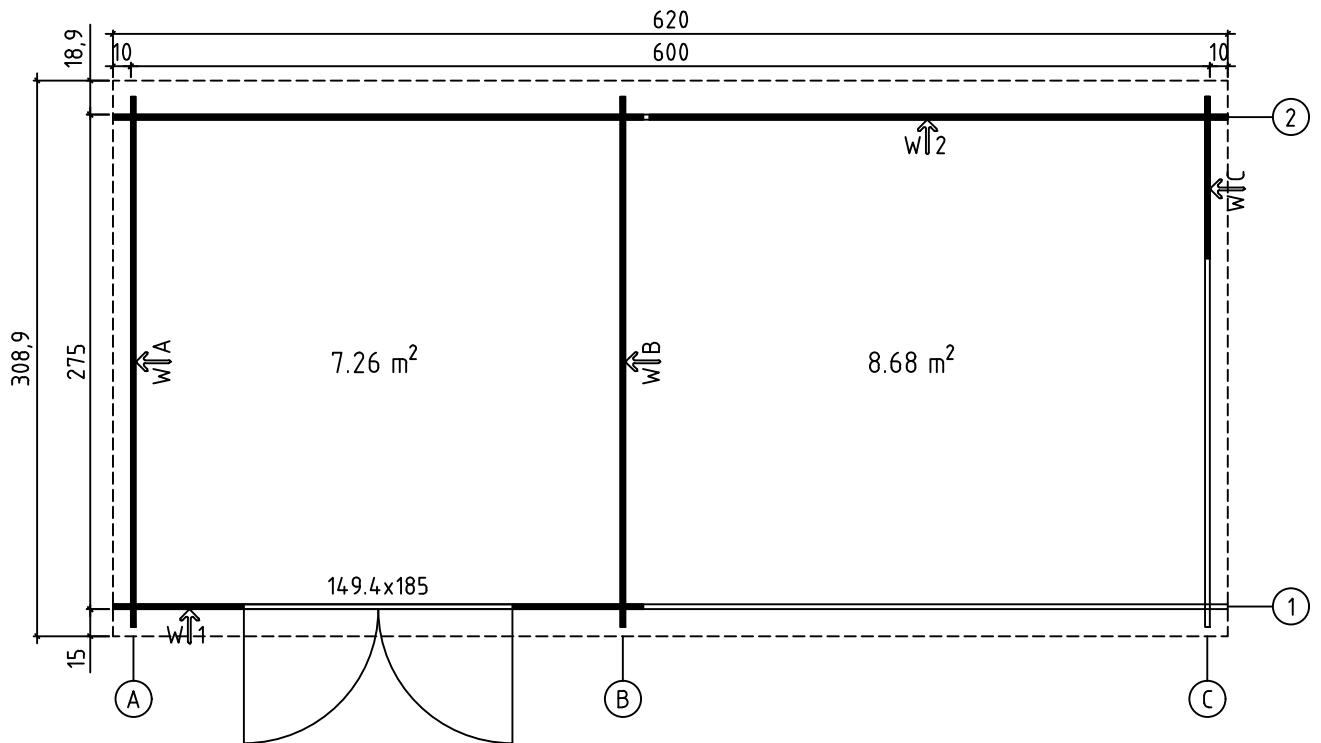

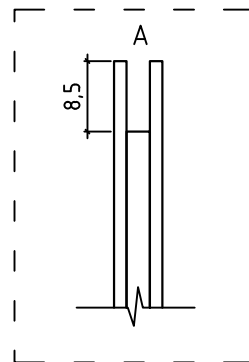
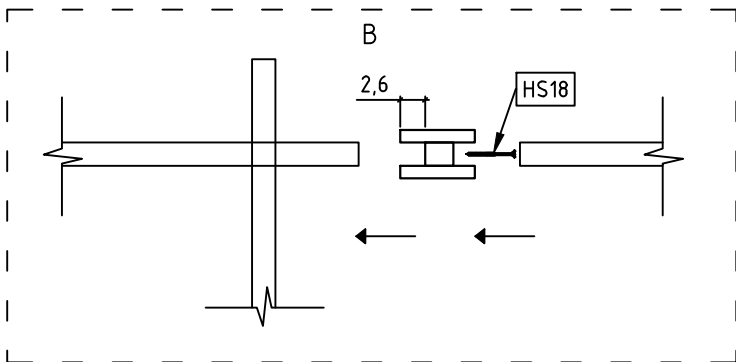
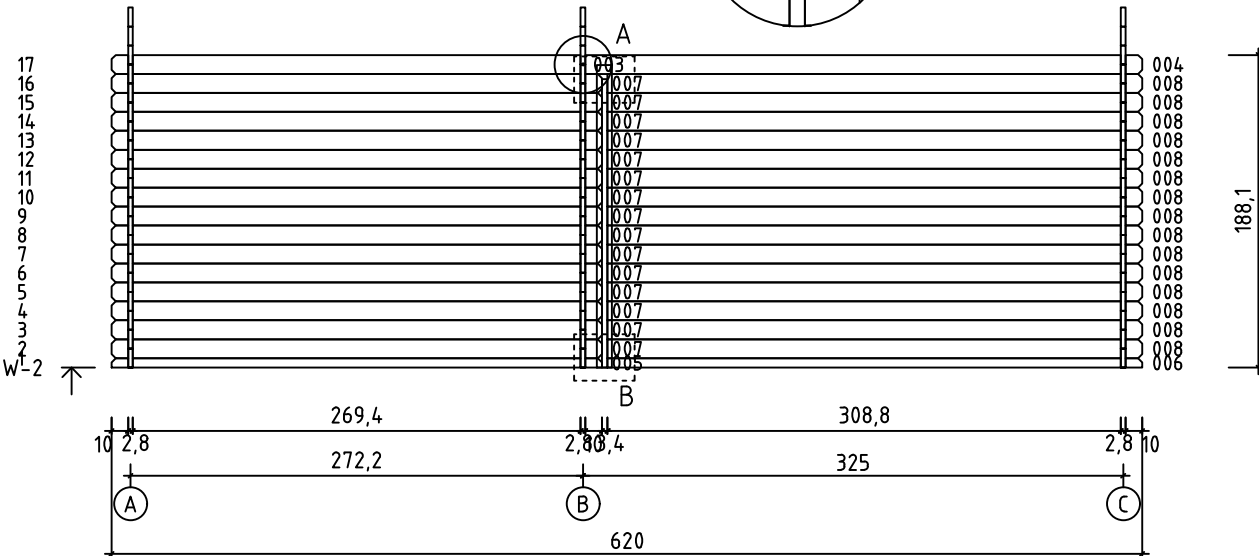
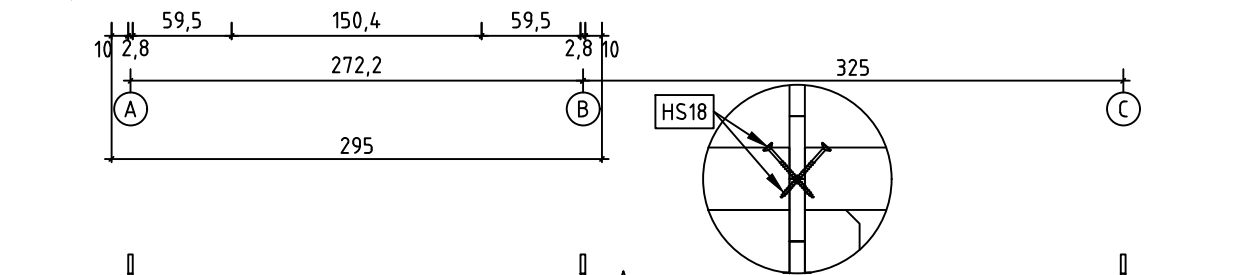
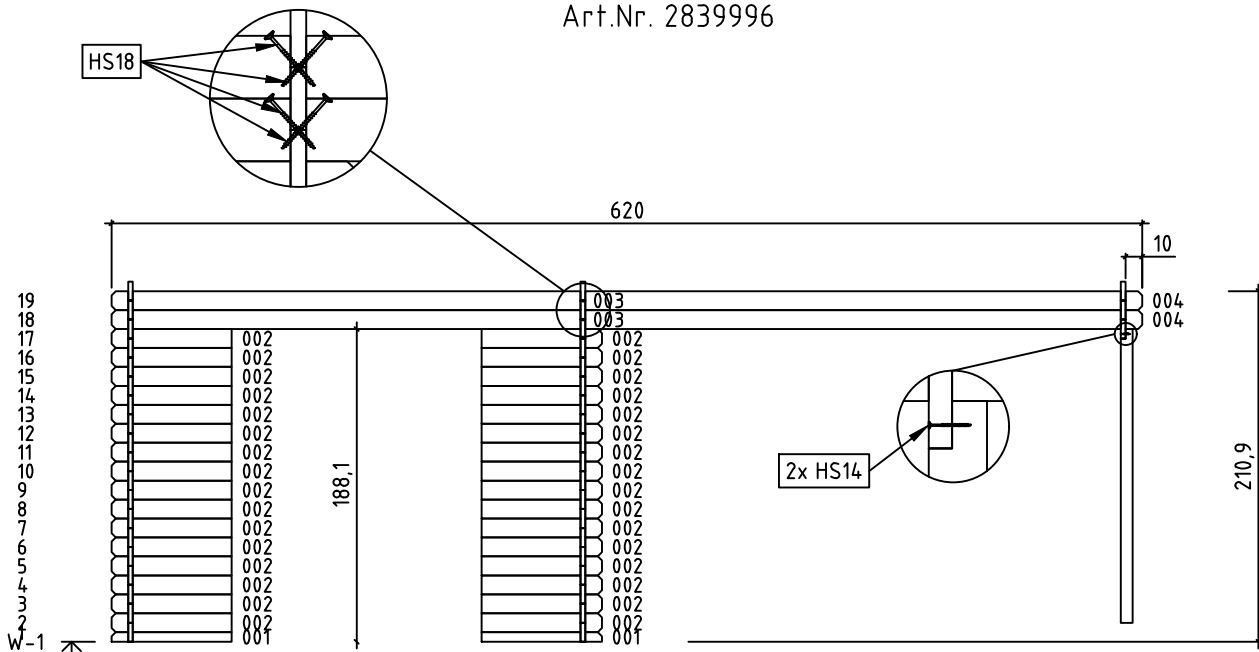

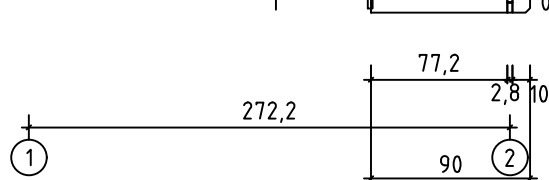
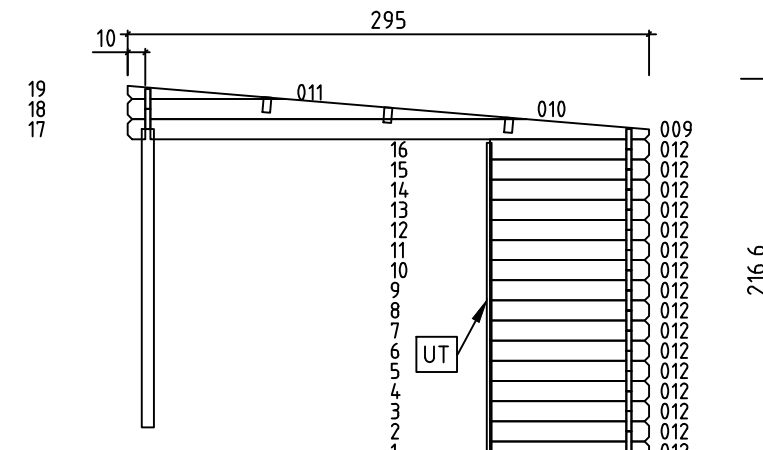
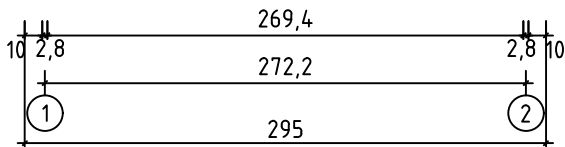
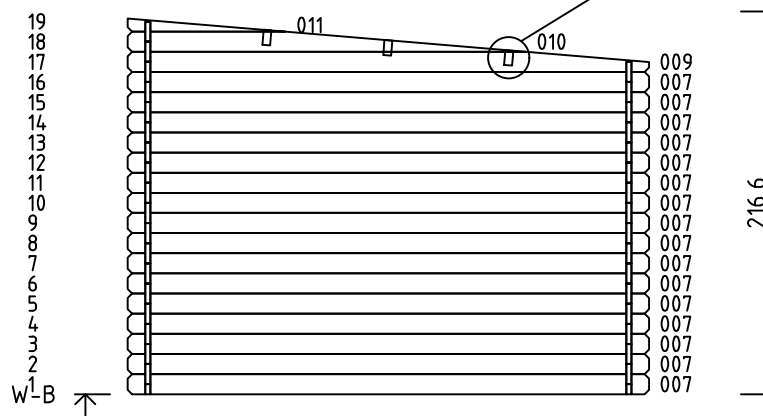
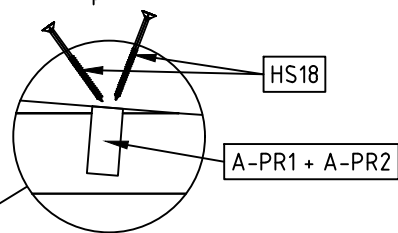
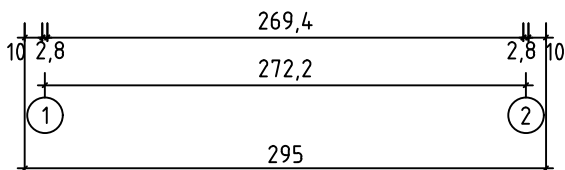
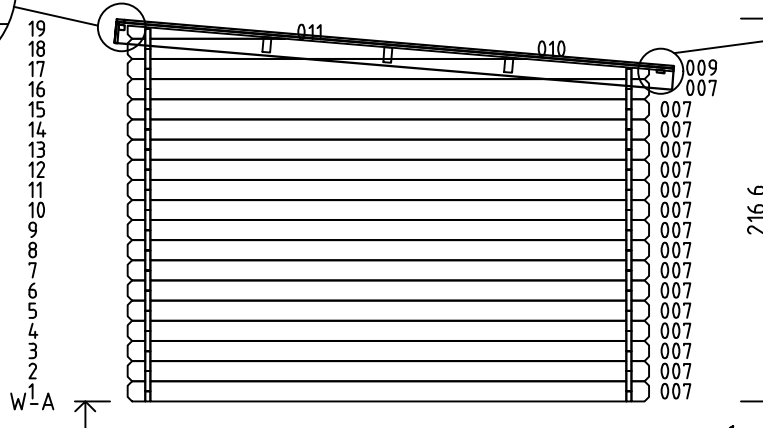
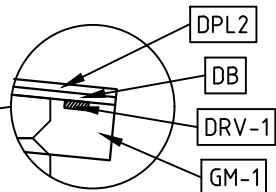
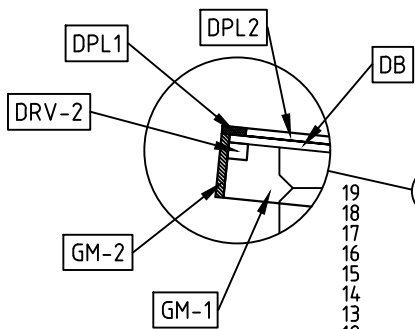
Art.Nr. 2839996

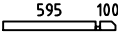
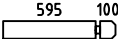
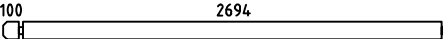
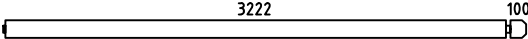
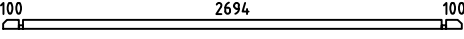
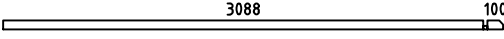
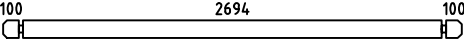
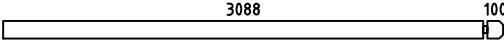
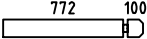
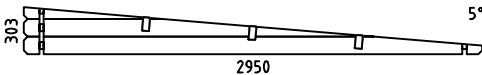
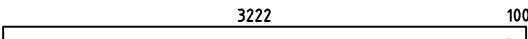
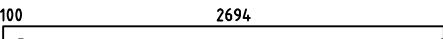
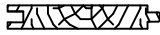

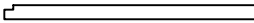







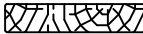
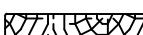
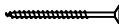

Groundplan - Grundplan - Plan de masse - Planimetria - Plattegrond -
Planimetría - Põhiplaan

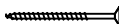
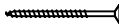
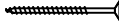
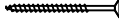
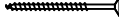

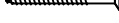



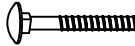



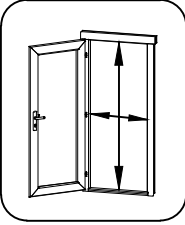
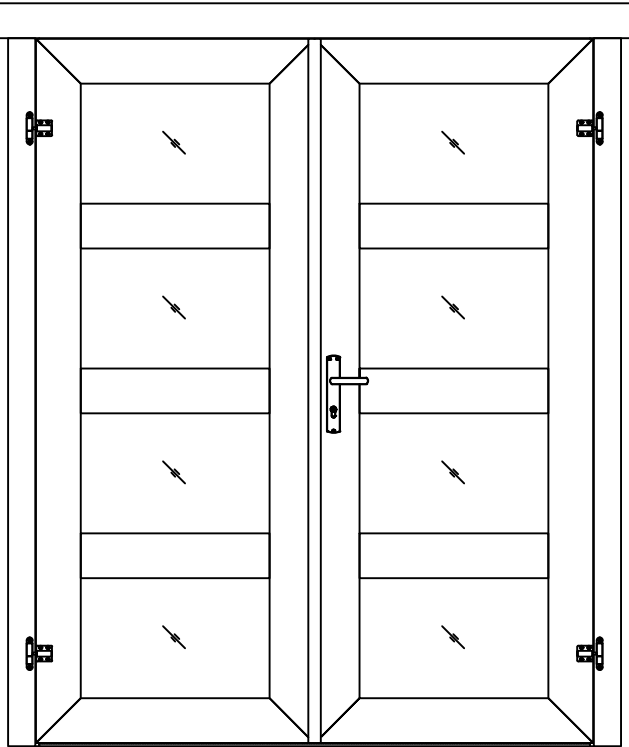

Pos	21.02.2024 Piece list - Stückliste - Liste des pièces - Elementi - Stuklijst - Elementos - Tükítabel Art.Nr. 2839996	5/6	Q	P (mm)	L (mm)
001 10843			2	28x57	723
002 10844			32	28x114	723
003 34591			3	28x114	2836
004 34530			3	28x114	3364
005 10853			1	28x57	2950
006 34532			1	28x57	3216
007 10854			4.7	28x114	2950
008 34533			15	28x114	3216
012 29850			16	28x114	900
WA-1 WB-1 WC-1 34520			1 1 1		
A-PR2 34534	Roof beam - Dachbalken - Panne de toit - Perlina del tetto - Gordingen / dakbalk - Correa - Pärilin 		3	44x146	3364
A-PR1 34535	Roof beam - Dachbalken - Panne de toit - Perlina del tetto - Gordingen / dakbalk - Correa - Pärilin 		3	44x146	2836
DB 34011	Roof boards - Dachbretter - Voliges - Perlina per tetto - Dakhout - Tablero de tejado - Katuselaud 		69	90x15.5	3100
DPL1 32851	Roofing felt fillet - Dachpappenleiste - Baguette de fixation du feutre bitumeux - Asse per fissaggio guaina bituminosa - Afdeklijst asfaltpapier - Moldura de fieltro para tejado - Katusepapiiliist 		2	15x45	3115
DPL2 25861	Roofing felt fillet - Dachpappenleiste - Baguette de fixation du feutre bitumeux - Asse per fissaggio guaina bituminosa - Afdeklijst asfaltpapier - Moldura de fieltro para tejado - Katusepapiiliist 		2	15x45	3120
P 34525	Post - Pfosten - Poteau - Piede registrabile - Stijl - Poste - Post 		1	90x90	1730
H 27597	H-profile - H-profils - Profile H - Profilo ad H - H-profiel - Perfil en H - H-profiil 		1	58x90	1820
DRV-1 25545	Roof edge reinforcement - Dachrandverstärkung - Corniere de renfort de bord de toit - Rinforzo x tetto - Dakrand versterking - Refuerzo de aleros - Räästatugevdus 		2	15x45	3100
DRV-2 32838	Roof edge reinforcement - Dachrandverstärkung - Corniere de renfort de bord de toit - Rinforzo x tetto - Dakrand versterking - Refuerzo de aleros - Räästatugevdus 		2	28x34	3100
KFS-1 2249	Storm protection - Sturmleiste - Latte anti-tempete - Protezione anti vento - Stormverankering / beveliging - Moldura antitormenta - Tormikinnitusliist 		5	22x45	2050
UT 34526	U-profile - U-profils - Profile u - Profilo ad u - U-profiel - Perfil en U - U-profiil 		1	28x58	1780

Pos	21.02.2024 Piece list - Stückliste - Liste des pièces - Elementi - Stuklijst - Elementos - Tükítabel Art.Nr. 2839996	6/6	Q	P (mm)	L (mm)
GM-2 34536	Gable moulding - Giebelleiste - Planche de rive - Finitura per frontale e retro del tetto - Gevellijst - Tablero de frontón - Viilulaud		2	15x120	3100
GM-1 34537	Gable moulding - Giebelleiste - Planche de rive - Finitura per frontale e retro del tetto - Gevellijst - Tablero de frontón - Viilulaud		2	15x120	3165
HS9 5106	Screw for u-profile - Schraube zur befestigung u-profilis - Vis a tete fraisée pour profil u - Vite per profilo ad u - Schroef ter bevestiging u-profiel - Tornillo para perfil en U - Kruvi U-profiitile		5	3.5x50	
HS9 5106	Screw for gable moulding - Schrauben für giebelleiste - Vis pour fixation planche de rive - Vite per fissare finiture davanti e dietro del tetto - Schroef voor gevellijst - Tornillo para tablero de frontón - Kruvi viilulauale		20	3.5x50	
HS4 5102	Screw for roof edge reinforcement - Schrauben für dachrandverstärkung - Vis pour fixation corniere renfort de bord de toit - Viti x rinforzo bordo tetto - Schroef voor dakrand versterking - Tornillo para refuerzo de alero - Kruvi räästatugevdusele		14	3x30	
HS14 5111	Screw for post - Schrauben für pfosten - Vis de fixation des poteaux - Viti per inviare - Schroef voor stijlen - Tornillo para poste - Kruvi postile		2	4.5x80	
HS12 5109	Screw for roof edge reinforcement - Schrauben für dachrandverstärkung - Vis pour fixation corniere renfort de bord de toit - Viti x rinforzo bordo tetto - Schroef voor dakrand versterking - Tornillo para refuerzo de alero - Kruvi räästatugevdusele		14	4x40	
HS12 5109	Screw for gable moulding - Schrauben für giebelleiste - Vis pour fixation planche de rive - Vite per fissare finiture davanti e dietro del tetto - Schroef voor gevellijst - Tornillo para tablero de frontón - Kruvi viilulauale		14	4x40	
HS13 5110	Screw for h-profile - Schraube zur befestigung h-profilis - Vis a tete fraisée pour profil h - Vite per profilo ad h - Schroef ter bevestiging h-profiel - Tornillo para perfil en H - Kruvi H-profiitile		1	4x60	
HS18 5113	Screw for roof beams - Schrauben für dachbalken - Vis pour fixation pannes de toit - Viti per perline del tetto - Schroef voor gordingen / dakbalken - Tornillo para correas - Kruvi pärliniitele		12	5x120	
HS18 5113	Screw for wall details - Schraube für wand details - Vis pour mur details - Viti per elementi della porta - Schroef voor wand details - Tornillo para elementos de pared - Kruvi seinadetailidele		6	5x120	
HS18 5113	Screw for gable - Schrauben für giebel - Vis pour fixation des pignons - Viti per timpano - Schroef voor gevelpunt - Tornillo para fijación de frontones - Kruvi viilude kinnitamiseks		12	5x120	
HS20 5118	Screw for post height adjustment - Schrauben für regulierungsschraube für pfosten - Vis de fixation de support réglable de poteau - Viti per fissare ed aggiustare l'altezza del palo verticale - Schroef voor hoogte instelling stijlen - Tornillo para anclaje - Kruvi vajumispoldile		8	6x50	
SH28 32509	Hammer block - Schlagholz - Calle de frappe - Blocco di legno da usare come cuscinetto quando si usa il martello - Slagklos - Bloque de impacto - Löögiklots		1		
SFS 5133	Nut for storm protection - Schraubenmutter für sturmleiste - Ecrou pour latte anti-tempete - Dado x asta protezione vento - Moer voor stromverankering - Tuerca para moldura antitormenta - Mutter tormikinnitusliistule		10	D6	
NF4 5137	Zn nail for roof - Zn nagel für dachbretter - Pointe pour fixation voliges de toit - Chiodi x perline tetto - Spijker(nagel) voor dakhout - Clavo para tablero de tejado - Nael katusetlauale		362	2x50	
NF5 5145	Zn nail for roofing felt fillet - Zn nagel für dachpappenleiste - Pointe pour baguette de fixation feutre bitumeux - Chiodi x carta bituminosa x tetto - Spijker(nagel) voor asfaltpapier afdekljst - Clavo de moldura de fieltro - Papiliistunael		28	2x40	
BFS 5155	Bolt for storm protection - Bolzen für sturmleiste - Boulon pour latte anti-tempete - Bullone x asta protezione vento - Bout voor stormankertaf - Perno de madera para moldura antitormenta - Puidupolt tormikinnitusliistule		10	6x60	
DFS 5125	Washer for storm protection - Dichtscheibe für sturmleiste - Rondelle pour latte anti-tempete - Rondella x asta protezione vento - Afdichtring voor storm strip - Arandela para moldura antitormenta - Seib tormikinnitusliistule		10	D6	
RP 34582	Post height adjustment - Pfostenräger verstellbar - Support réglable de poteau - Piede registrabile in altezza - Stelschroef voor stijlpst - Anclaje - Vajumispolt		1	D20	
34579	Door - Tür - Porte - Porte - Deur - Puerta - Uks TUK.4.020.SVP.MMX28 SGA+28		1		

Pos	18.12.2017	Piece list - Stückliste - Liste des pièces - Elementi - Stuklijst - Tükítabel 14 94x1850 TUK.4.020.SVP.MMX28 SGA+28	1/2	Q	P (mm)	L (mm)
Glass size - Glasgröße - Taille de la vitre - Misura del vetro - Glas afmeting - Klaasi mõõt: 502x325 mm					 1418x1792 mm	
						
1	Upper door jamb - Türrahmen oben - Cadre de porte supérieur - Telaio superiore della porta - Bovendorpel - Ukse ülemine leng			1	66x100	1438
2	Left door jamb - Türrahmen links - Cadre de porte gauche - Telaio montante sinistro della porta - Linkerstijl deurframe - Ukse vasak leng			1	66x80	1850
3	Right door jamb - Türrahmen rechts - Cadre de porte droit - Telaio montante destro della porta - Rechterstijl deurframe - Ukse parem leng			1	66x80	1850
4	Doorstep - Swelle - Barre de seuil - Soglia della porta - Deurdorpel - Lävepak			1	20x21	1418
5	Connection strip - Deckleiste - Baguette de battement - Profilo verticale della porta - Stulplijst - kokkuvaltšiliist			1	13x32	1812

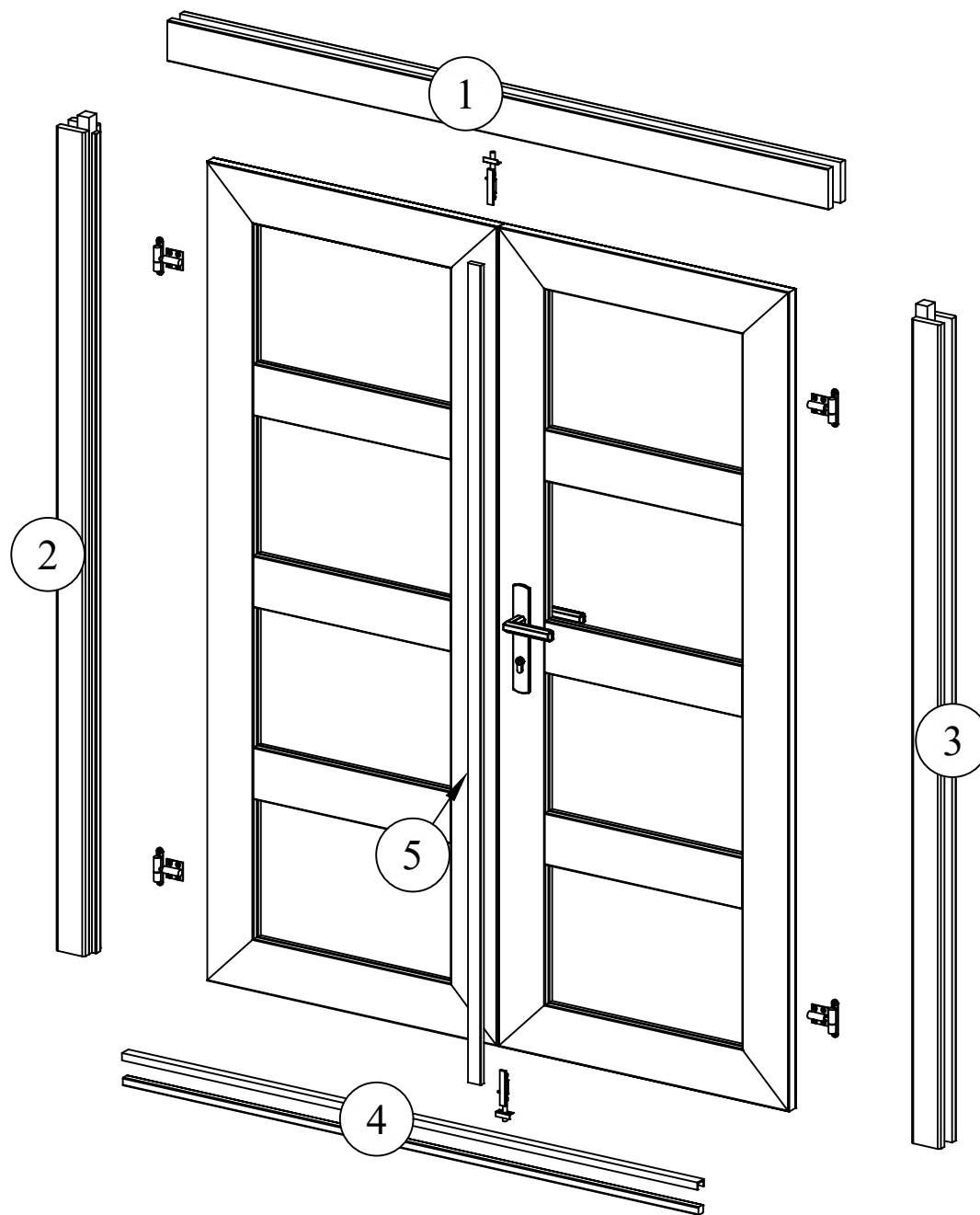

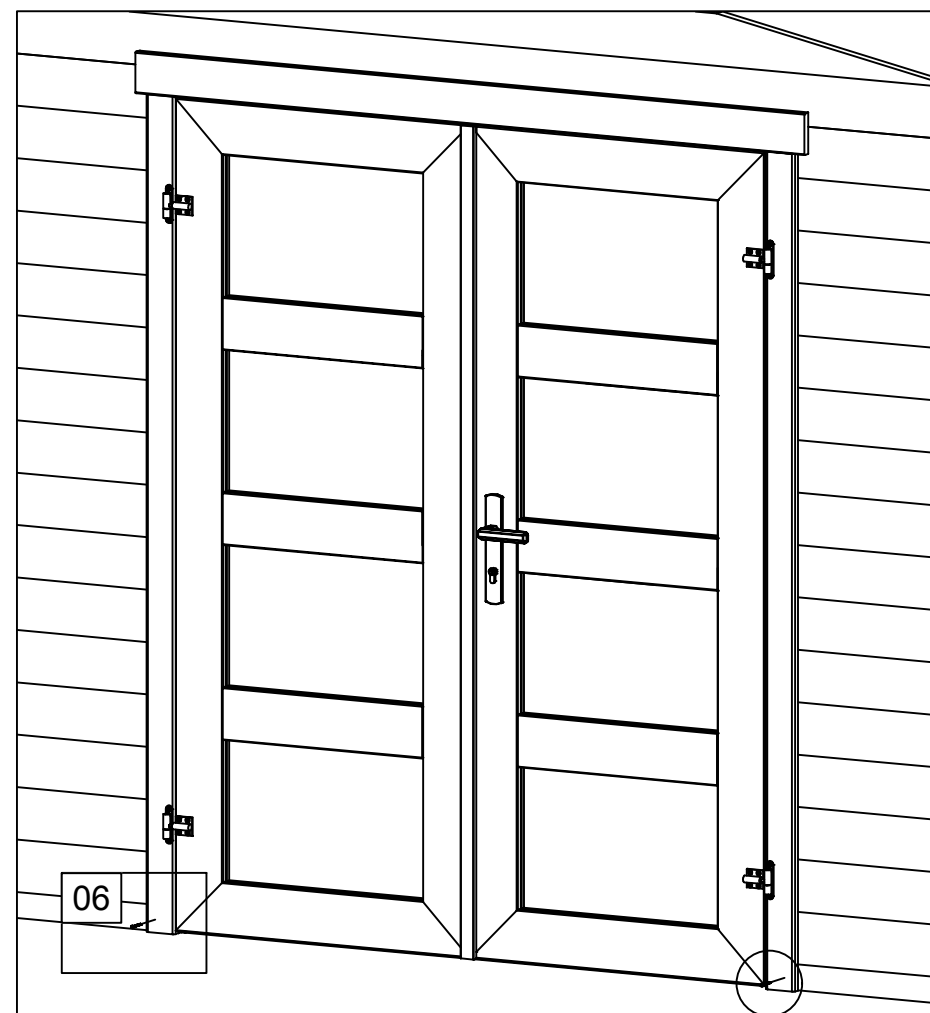
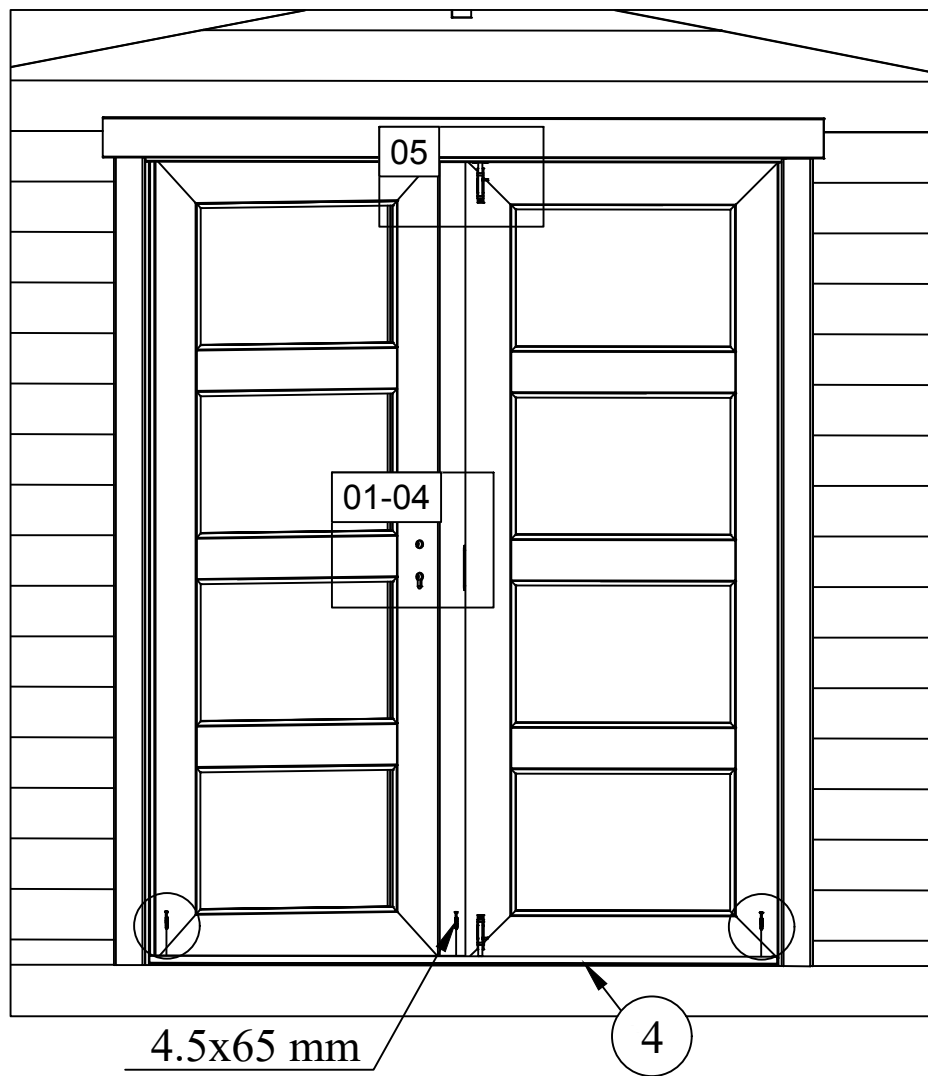

01

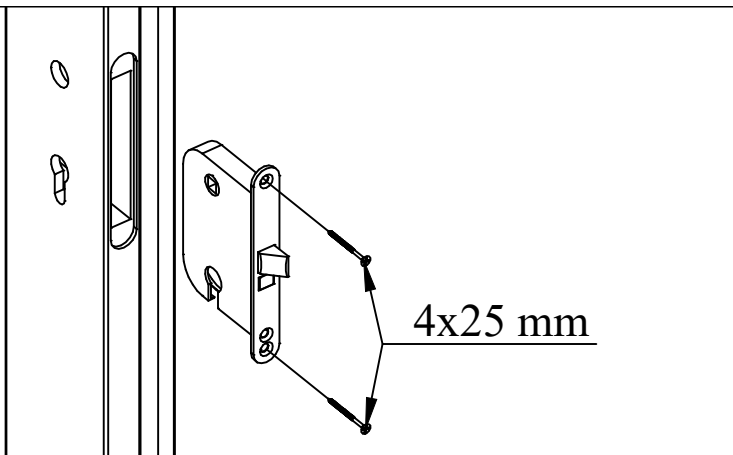

04



02



05



03



06

